

Application examples

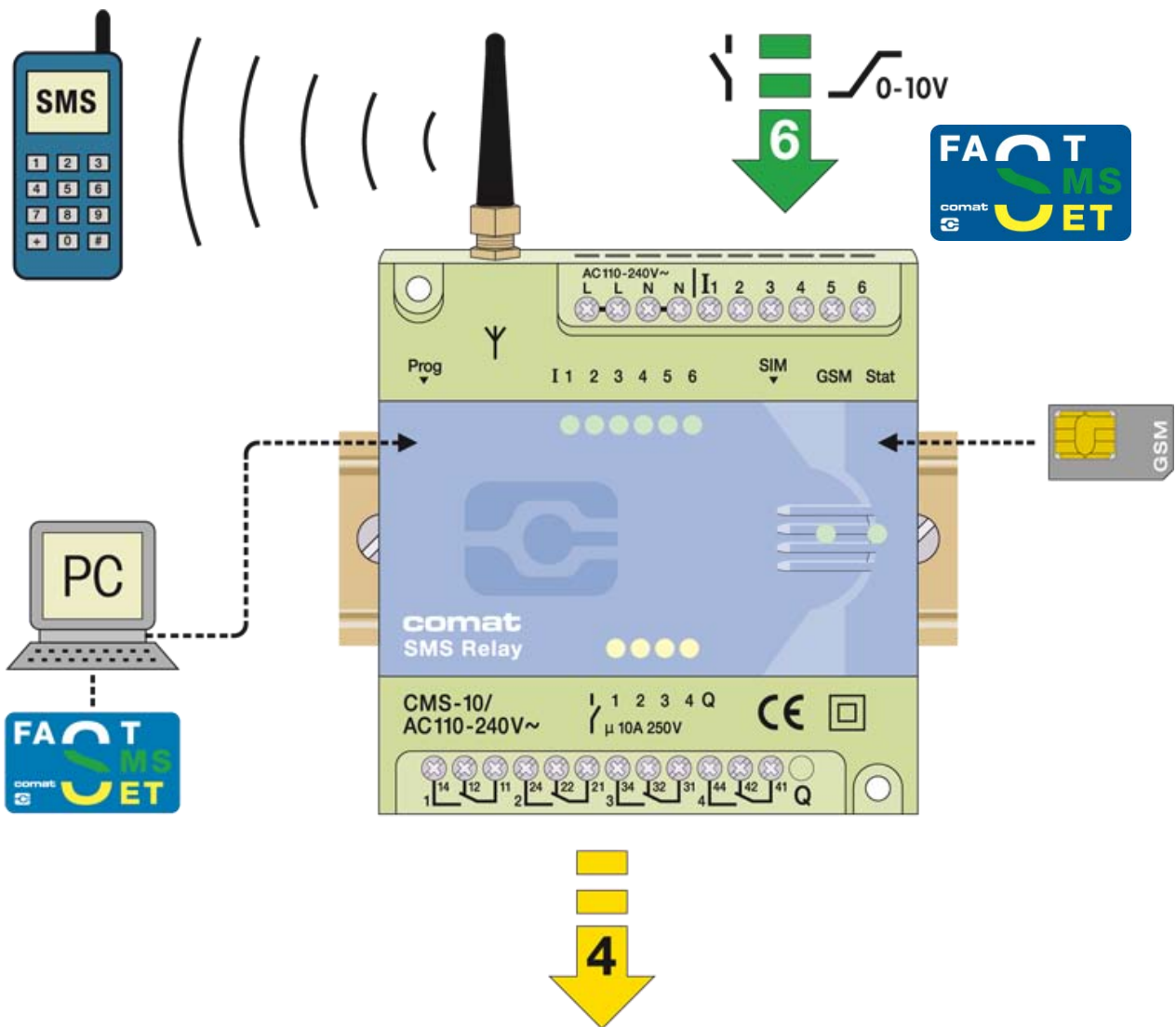



Content

1 Safety instructions3
2 HVAC / Facility Management.....4
3 Level control in a pump station5
4 Toolshop with CNC turning lathes and – drill machines6
5 Heating oil tank / Oil distributor7
6 Unpaid bills8
7 Cottage in the mountains9
8 Milk cooling system on a farm.....10
9 Surveillance of a server room11
10 Supervising a small electrical power plant12
11 Cold-storage room monitoring13
12 Communcation between two COMAT SMS Relay14



1 Safety instructions

WARNING *The electrical installation of the SMS relay must be carried out by a professional person*



Please read the complete operating instructions before installation and commissioning!

Injuries and or damages cannot be excluded if these warnings are neglected

WARNING *This device is not suitable for monitoring sensitive installations or time critical processes. GSM network failure or power interruptions cannot guarantee a secure monitoring.*



WARNING *This device shall not be used in explosive endangered environment or close to medical appliances.*



REMARK *The individual responsibility for protecting the SIM card against abuse lies solely with the card owner.*



The use of a prepaid SIM card is possible. It is recommended to use a SIM card with subscription. This avoids possible credit balance problems.

REMARK *Comat AG does not accept any liability for possible damage to persons, buildings and/or machines, which occur due to incorrect use or from not following the instructions or abusing the device. Comat AG cannot accept any responsibility for the application and use of the SMS relay. In particular Comat AG cannot guarantee the connection security with the mobile network.*





2 HVAC / Facility Management

Initial application

To monitor a central heating installation in a large building complex for apartment heating and hot water supply. A 24/7 call out & maintenance contract is required to look after the central heating system by a facility management company. By sending early alarm and failure messages to the maintenance person on duty, the central heating system can be maintained before the whole installation is out of order and the water is cold.

Solution

All the critical and important alarms of the installation are connected to the inputs of the SMS Relay. The temperatures from the sensors at the supply and return lines of the heating system are transmitted as an analogue signal (0...10V). According to the configuration of the thresholds (temperature high, temperature low, temperature difference ΔT) the SMS Relay will send messages by SMS to a mobile phone. The temperature can be requested manually or sent periodically by SMS automatically.

The digital alarm inputs are also connected to the inputs of the SMS Relay. These alarms are from the pumps and the burner, the status (operation, failure) of that equipment is transmitted by SMS.

The alarm receiver can request other important temperatures of the heating system. With the information about the condition of the system, the decision of what action is required can be taken easily. Maybe the problem can be solved by sending a SMS to the SMS Relay to restart the burner again or to switch 'ON' a backup system.

Benefit

A breakdown of the whole heating system will be recognised early by the facility management or by the maintenance contractor. A sudden drop of temperature will be recognised and a predefined message at the specific pre-set threshold is sent. The failure time is shorter or a breakdown may be avoided because of early intervention after receiving of an alarm message. For example down time may be reduced by sending a SMS message to the system to restart the burner. No immediate manpower is needed to go on site.

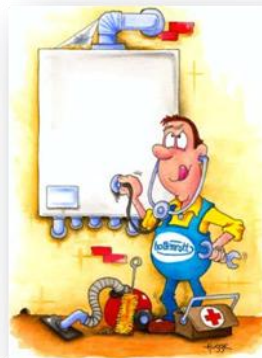



3 Level control in a pump station

Initial application

Inlet and outlet of a pump station are normally aligned to each other. However, if the level of the reservoir rises faster than normal (e.g. increased inlet because of heavy rainfalls), as soon as the level reaches the critical threshold and to avoid an overflow, it is possible to open a valve or to switch 'ON' a second pump for the outlet.

The facility manager receives a message as soon as the level reaches the critical point. If the responsible person is not close to the facility, he can send an SMS and switch 'ON' a second pump. With two running pumps, the level will not rise any further and may even fall. Once the level reaches the normal range, the facility manager will get another message with the information and now he can switch 'OFF' the second pump by sending an SMS message.

Solution

The flow (e.g. liter per minute) of the inlet and the outlet and the level of the reservoir are connected as an analogue 0...10V-signal to the corresponding inputs of the SMS Relay. The status of the two pumps (failure/operation) and of the valve (open/closed) is connected to digital inputs of the SMS Relay. If the pre-defined thresholds of the flow is reached or if the level of the reservoir rises very fast (difference per time coefficient), a corresponding alarm is sent by SMS.

It is up to the receiver of the alarm message to plan further actions. Even if this person is not close to the pumping station, other important values from the pump station can be checked by sending a status request SMS. For example: - values like the status of the pump (failure/operation) or the actual flow in liter per minute. By knowing these values, it is easier for the person in charge to plan his next steps. Maybe the problem can be solved by switching 'ON' a second pump or by opening a valve. To monitor the situation, the values (level, flow) can be monitored and requested at any time by SMS messages.

All pumps can be switched 'OFF' and the valves can be shut after the normal situation is restored.

Benefit

The pumping station can be operated by remote control. It's not necessary to be present at the pump station to operate the single components and to observe the installation.

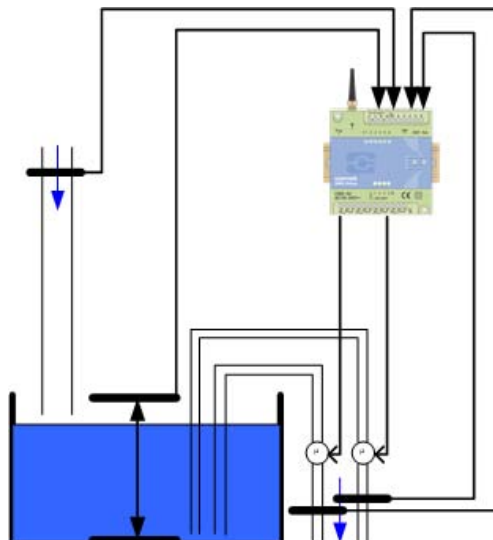



4 Tool shop with CNC turning lathes and drilling machines

Initial application

A mechanical workshop operates turning lathes and drilling machines with three working shifts of 24 hours/day. Two shifts are manned with operators. The last shift from 10pm to 6am is unmanned. All machines need cooling fluid. The fluid is stored in a central tank and is distributed to the machines from this tank with a piping system. After cleaning, the recycled fluid is pumped back into the central tank. The fluid cleaning filters have to be cleaned and replaced frequently due to the remaining drilling chips in the fluid. From time to time the filter can get clogged. During normal working shifts such a failure is solved in a short time. During the unmanned shift however, all the machines are stopped until someone cleans or replaces the filter.

Solution

A flow meter is built in the cooling fluid pipe. The signal, which is connected to the inputs of the SMS Relay, is an analogue signal (0...10V). The flow rate is an indicator of the pollution of the filters. The setting of a threshold for a too low flow rate helps to spot an upcoming blockage of the filter. As soon as this threshold is reached, a SMS message is sent to the relevant duty engineer. During the day shifts, the shift supervisor is responsible for cleaning the filter. During the unmanned shift in the night, the facility manager or duty engineer of the factory will receive the message. The filters can be cleaned before all the machines are shut down, preventing a break in production.

For control reasons, the flow rate can be checked from time to time by sending a status request to the SMS Relay.

Benefit

With this monitoring system, alarming happens on time, therefore there are no down time of the tooling machines during unmanned shifts and subsequently no delivery delay.





5 Heating oil tank / Oil distributor

Initial application

An oil fired heating system is responsible for hot water and a comfortable room temperature. If there is enough oil in the tank, the oil heating generates the heat. If the oil level is not checked regularly, the oil tank can run empty without warning.

Solution

The oil level is connected to the input of the SMS Relay as an analogue 0...10V-signal. This input is configured as an analogue input and the lower threshold of this input is configured with the minimum oil level on which ordering a tank refill becomes necessary. As soon as this level is falling below the pre-set value, a SMS message is sent to the oil supplier. In this message the oil supplier finds the address, the actual oil level and the whole tank capacity. The only thing to do for the oil supplier is to contact the house owner and to arrange a delivery date.

In addition, the house owner can control the actual oil level by sending a SMS message with level request to the monitoring SMS relay at any time he wants.

The digital alarm inputs are also connected to the inputs of the SMS Relay. These alarms are from pumps and/or the burner. The status (operation/failure) of those parts is also sent by the SMS Relay. A failure in one of these parts of the system will generate a SMS message to the heating engineer. Before the heating engineer drives to the address, he sends a SMS to the SMS Relay to restart the burner.

Benefit

No more cold feeds by failures of the heating system because of an empty oil tank. Failures of the burner may be remotely solved without having the heating engineer on-site.

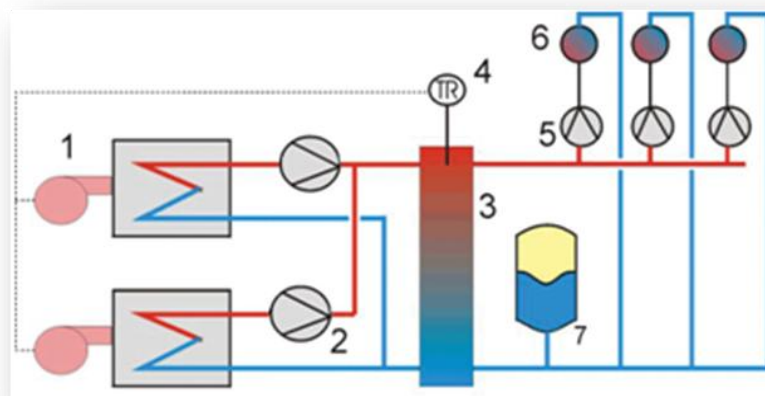



6 Unpaid bills

Initial application

Many building cranes are rented. The payments dates of the construction companies to the rental companies can be different. Some of them fail to pay on due date.

Solution

If the bills are not paid and the request for payment has not been successful, the crane rental company can disable the crane just by sending a SMS to the dedicated SMS Relay. If the payment took place, the crane can be enabled by sending another SMS to the SMS relay.

Benefit

The rental company can enable a crane after the hiring period without any installation on-site at the crane.





7 Holiday Cottage in the mountains

Initial application

The mountain week-end cottages are not used regularly. All the important equipment for living comfort shall be controlled by remote control. Before departure to the cottage, all the corresponding functions can be controlled via SMS messages.

Solution

The signal from the temperature sensor is a standard 0...10V analogue signal and is connected to the defined analogue input of the SMS Relay. The pre-defined thresholds are sending alarm messages by SMS, e.g. the sensor for the room temperature is sending a SMS if the temperature goes to low. The owner can react by sending a SMS to turn up heating, controlled by an output contact of the SMS Relay. If necessary, the actual room temperature can be requested by another SMS.

In order that all the drinks in the refrigerator are well cooled at arrival, sending a SMS message to switch 'ON' the device three hours before arrival solves this problem.

Switch 'ON' the water heating system the day before arrival will heat up the water with lower night energy tariff during the night and the water will be hot on arrival.

The sun can not warm up the swimming pool to comfortable 25°C during the travel time. The additional heating for the swimming pool can be switched 'ON' by SMS some hours before arrival or when the weather does not forecast sun for the next few days.

During winter time the drive-in to the garage may well be covered with snow at times. In order that the car can access the steep drive in garage entrance, an SMS message can be sent to switch on the floor heating of the garage drive way to allow access by melting the ice or snow.

All the doors and the windows on the ground and first floor are secured by sensors (breakage of glass, windows or door contact...). Should a winter storm or intruder break a window the SMS Relay sends a message immediately, so action can be taken.

Benefit

Higher comfort by controlling the cottage via SMS: The cottage is always warm; the drinks are cool at arrival, no more access problems to the drive in garage.

The screenshot shows the configuration interface for the SMS Relay, specifically for temperature monitoring. It includes a graph of Voltage on input [V] vs. Temperature [C] and various settings for messages and periodic requests.

Scaling and unit:
 Unit: C
 Decimal format: 0.0
 max.: 35.0 C
 min.: 5.0 C

Messages:
 Room temperature is too high! 25.0 C
 Room temperature is OK! 18.0 C
 Room temperature is too low!
 If change is > than 1.0 C
 Level has changed and is now:

Message delay: 1.0 s
Message lock time: 1.0 s
Send value periodically: Daily Weekly Monthly
 15:30 Monday 25

Periodic message:
 Room temperature is
 Request: Room temperature?
 Answer: Room temperature is:



8 Milk cooling system on a farm

Initial application

Milk has to be cooled to prevent it going sour. In many places milk will not be transported to the cheese dairy on a daily basis. The farmer or farmers may collect & store the fresh milk in a single cooled milk tank.

Solution

The signal "milk temperature" is a standard 0...10V analogue signal and is connected to the defined analogue input of the SMS Relay. The pre-defined thresholds are sending alarm messages by SMS.

The operation status of the compressor (operation/failure) is connected to a digital input of the SMS Relay. The alarm messages for operation and failure will be defined and saved in the configuration file.

If the compressor fails, the SMS Relay sends a failure message. The receiver of the message can request by SMS the actual temperature of the milk inside the tank. With this information he can decide how fast he has to react. As soon as the milk temperature rises to the critical level, the SMS Relay sends the alarm message for "high temperature". At this point, the reaction time has to be short.

If the compressor over heats, after a short waiting time, it may be possible to restart the compressor by sending a SMS message. One output of the SMS Relay has to be integrated into the control circuit. **WARNING:** There is normally a reason for an overheated electromotor and this must be investigated to prevent any damage within the installation.

Benefit

No matter where the farmer actually is, with the SMS Relay he has the possibility to react before the milk becomes unusable.





9 Monitoring of a server room

Initial application

Server and server rooms are very important for a company. To avoid problems and to guarantee a failure free operation, servers and server room temperatures should be monitored all the time.

Solution

The signals from the temperature sensors (room temperatures, server temperature) are a standard 0...10V analogue signal and are connected to the defined analogue inputs of the SMS Relay. The pre-defined thresholds are sending alarm messages by SMS.

The digital signal "power failure" from the zero-voltage relay is hooked up to an input of the SMS Relay. If a power failure lasts too long, the available backup time of the UPS may run out. An alternative power supply has to take over. This backup system is activated with a SMS message and started over an output contact of the SMS Relay.

The humidity sensor on the floor provides the warning signal of a possible water inrush into the server room. The signal is connected to a digital input of the SMS Relay.

Relay outputs can shut down the server by sending a SMS.

The receiver of the alarm message can request further information, depending of the information message received from the SMS Relay (e.g. temperature of a server or the rooms ambient temperature) the next steps are planned.

Benefit

The monitoring of the server, server room and alarms in real time are assured. Messages that are not acknowledged are automatically forwarded to a next receiver. Important and sensitive data's are protected from loss. Adequate actions can be taken to avoid damage, even if there is no technician nearby.

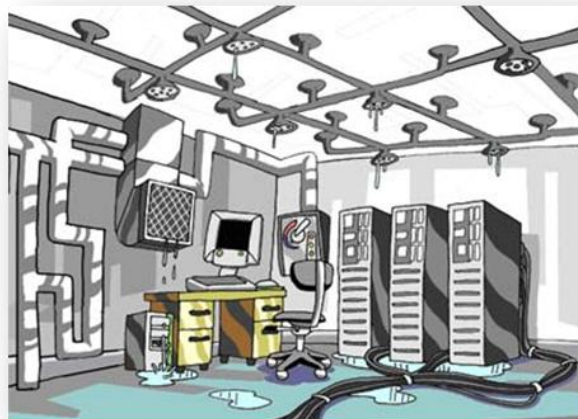



10 Monitoring of a small electrical power plant

Initial application

As bigger power generation plants are integrated into a general monitoring & control system, this may not be economical for smaller power plants. Nevertheless, to avoid a blackout, small power plants also need to be monitored.

Solution

The frequency of the alternating current is connected to the analogue input of the SMS Relay as a 0...10V analogue signal (via a converter). The upper and lower thresholds correspond to the higher and lower frequency values of the power station. The pre-defined SMS alarm messages are alerting the maintenance crew.

The temperature of the generator (in a hydraulic power station) or of the AC/DC converter (in a solar power station) is hooked up to an analogue input of the SMS Relay as a 0...10V analogue signal.

If the temperature rises to a critical temperature (sign of overheating) or at a status of critical frequency change, the power station has to be cut off from the power network. This can be either controlled automatically by the control system or alternatively, manually by the person on duty after he has received an alarm message by a SMS. A main switch, controlled by an output of the SMS Relay, separates the power plant from the power network. This command is activated by SMS to switch one of the outputs of the SMS relay. At the same time, the power production has to be stopped, e.g. throttling of the water inlet to the pelton wheel of the hydroelectric turbine.

Benefit

The power station is protected and damage can be avoided. Adequate actions controlled by the receiver of the alarm message, even if the receiver is not on site of the power station.

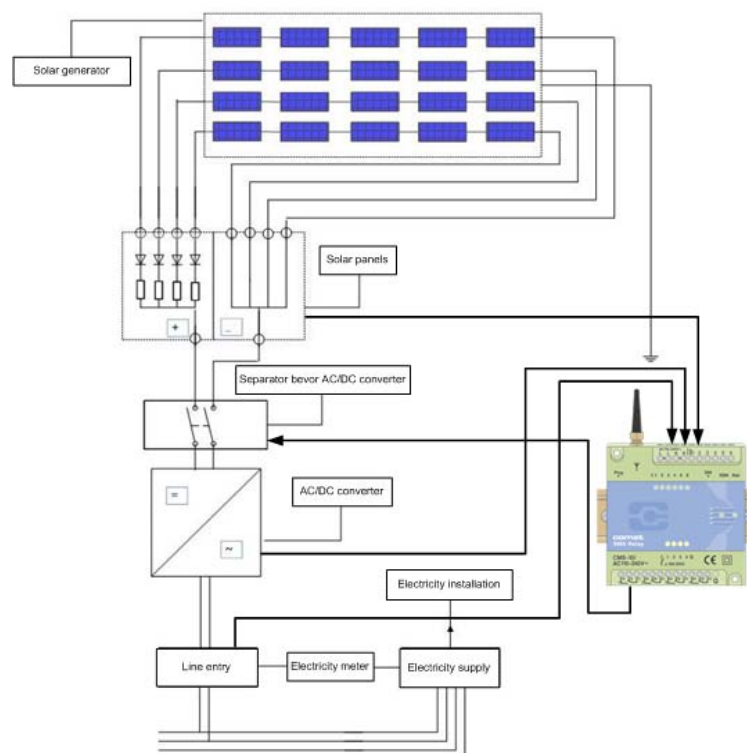



11 Monitoring of a cold-storage room

Initial application

A cold storage room cools all kinds of food and beverages (perhaps also medicines) to a constant temperature. A very high reliability of the cooling unit is essential. It is therefore necessary to monitor the temperature of all the cooling cells permanently. Early detection of failures enables the maintenance team to react on time and before the stored produce becomes unusable.

Solution

All the important parameters (temperature, cooling unit status, etc.) are connected to analogue inputs of the SMS Relay as 0...10V analogue signals. The upper and lower thresholds correspond to the highest and lowest permissible temperature values. The pre-defined alarm messages are informing the maintenance crew in case of irregularities.

The operation statuses of the cooling unit (operation/failure) are connected to digital inputs of the SMS Relay. The alarm messages for operation and failure are defined with the easy to use configuration software and downloaded to the SMS Relay.

As soon as a value has crossed the defined maximum 'upper/lower' temperature level, the SMS Relay sends the pre-defined SMS alarm message to one or several receivers. The alarm receiver acknowledges the message and can request further values by SMS to get more information about the actual status

E.g. with an output contact on the SMS Relay a second cooling unit can be switched 'ON' by SMS for cooling support.

Benefit

The first intervention to an alarm can be executed from any remote location. The alarm receiver does not need to be present locally and adequate actions can be taken immediately and before the stored goods are wasted.





12 Communication between two COMAT SMS Relays

Initial application

Two pumping stations on different sites are monitored by SMS Relays. Normally the two pumping stations are working autonomous. In case of heavy rainfalls they have to interact together. (One pump to switch 'ON' the second pump for support).

Solution

The SMS Relay from site A is registered as an alarm receiver of the SMS Relay from site B. Vice versa the SMS Relay B receives SMS messages from SMS Relay A. If SMS Relay A gets a signal on input I1, a message is sent to SMS Relay B. This message controls the output O2 and switches a pump. At the same time SMS Relay B sends a confirmation message to A to avoid further emitting of alarm messages. In case the switching command is not received by SMS Relay B or no confirmation is registered by SMS Relay A, the message is forwarded to the next phone number in the defined alarming chain. This number belongs to a person on duty, who can go on-site to switch 'ON' the pump manually.

Benefit

Two pump stations are communicating without large investments via SMS messages. The status is monitored permanently and the pumps support each other independently and effectively without direct human involvements. Possible malfunctions are reported by SMS messages to personal on duty as a backup if communication fails between the units.

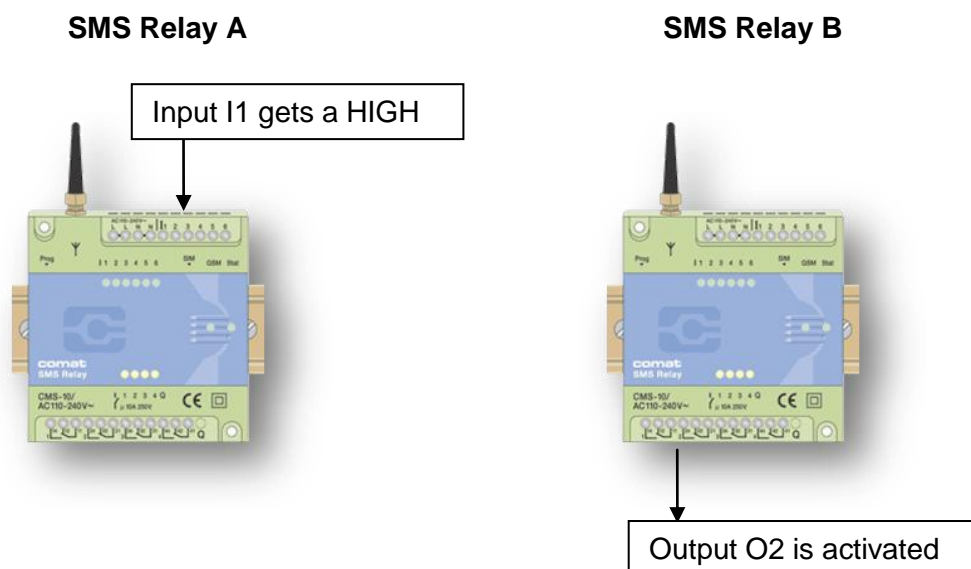



SMS Relay A

General settings

Select device type: CMS-10 Digital

Enter PIN 1: ****

Provider search: Automatic Manual

GSM Service Provider: 123456,SWISS GSM

SMS Service Center: +41794999000

SMS Relay description: SMS Relay A

Enable Remote Access

Enable Local Authentication

Password: *****

Send status message to:

1. Receiver: John, +417977799777

2. Receiver: []

3. Receiver: []

4. Receiver: []

5. Receiver: []

SMS Relay B

General settings

Select device type: CMS-10 Digital

Enter PIN 1: ****

Provider search: Automatic Manual

GSM Service Provider: 123456,SWISS GSM

SMS Service Center: +41794999000

SMS Relay description: SMS Relay B

Enable Remote Access

Enable Local Authentication

Password: *****

Send status message to:

1. Receiver: John, +417977799777

2. Receiver: []

3. Receiver: []

4. Receiver: []

5. Receiver: []

[SMS Relay description

Send status message to:

1. Receiver: SMS Relay B,+417878787878

2. Receiver: John, +417977799777

3. Receiver: []

4. Receiver: []

5. Receiver: []

Confirmation

Waiting for confirmation: 10 Minutes

Number of loops if no confirmation received: 2 Repetitions

Keyword for confirmation: OK

If not selected. No keyword needed for confirmation. Confirmation by identification of senders phone number. (Any or no message text)

ON / OFF instruction]

Number identification

ON instruction: SMS Relay A Pumpe1#ON

OFF instruction: SMS Relay A Pumpe1#OFF

Confirmation after switch ON

SMS Relay B

Pumpe1 ON

Remaining chars for message (max. 98 chars)

Confirmation after switch OFF

SMS Relay B

Pumpe1 OFF

Remaining chars for message (max. 98 chars)

Digital / Analog

Event message (input is HIGH)

SMS Relay A

Pumpe1#ON

Remaining chars for message (max. 98 chars): 87

ON message delay (SMS send only if input is continuous HIGH during the set time)

1:0 (0,1,...99,9) [] [] [] []

Event message (input is LOW)

SMS Relay A

Pumpe1#OFF

Remaining chars for message (max. 98 chars): 86

OFF message delay (SMS send only if input is continuous LOW during the set time)

1:0 (0,1,...99,9) [] [] [] []



Kühn Controls AG

Notes:

You want more information about this product, please call us: tel: +49 (0)7082-940000 or send us a fax: +49 (0)7082-940001, or email: sales@kuehn-controls.de or visit our Website: www.kuehn-controls.de